

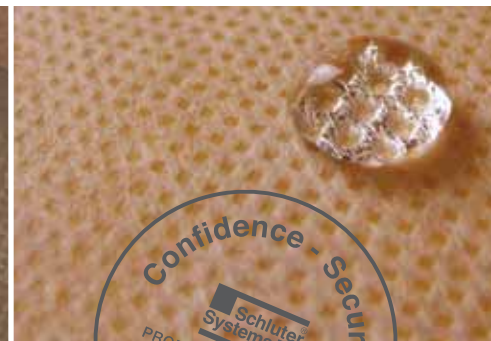

Schluter®-Shower System Installation Handbook 2008

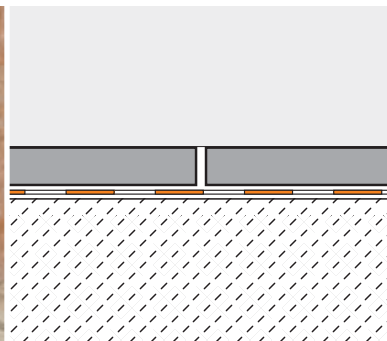

Bonded Waterproofing System for Tiled Showers,
Steam Showers, and Bathtub Surrounds



Schluter®-Shower System

Bonded Waterproofing System for Tiled Showers, Steam Showers, and Bathtub Surrounds

Ceramic and stone tiles are durable, easy to maintain, and hygienic, representing the ideal surface coverings, particularly in wet areas such as showers and bathtub surrounds. These coverings are not inherently waterproof, however, and must be installed in conjunction with a waterproofing system that effectively manages moisture to protect moisture-sensitive building materials and control mold growth.

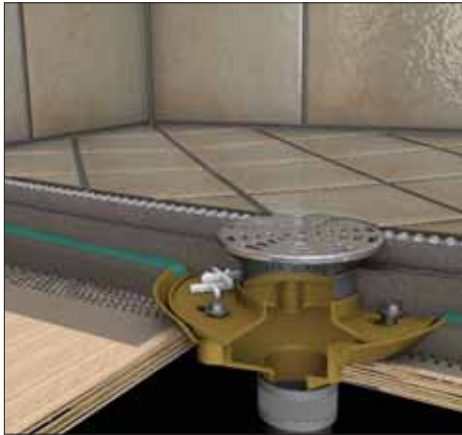

The Traditional Tiled Shower System

The traditional method for installing tiled showers is time and labor intensive and creates a “water in/water out” system. First, a mortar bed is sloped to the weep holes in the drain. The waterproofing membrane, called a pan liner, is placed over this “pre-slope” and clamped into the drain. Pan liners do not allow for the direct application of ceramic or stone tile. Thus, another mortar bed must be installed to provide load distribution and a bonding surface for the floor tile. Finally, a moisture barrier typically must be included behind the solid backing on the walls (e.g., mortar, cement backerboard, etc.) and lapped over the pan liner to protect the wall cavities from moisture penetration and divert that moisture into the pan.

Contrary to popular belief, the tile covering itself is not waterproof. Moisture will infiltrate the mortar bed and solid backing on the walls. This moisture must percolate through the mortar bed to the sloped pan liner and exit through the weep holes in the drain. With regular use of the shower the mortar bed can remain saturated, particularly if pre-slope installation is ignored or the weep holes become clogged, thus increasing the potential for efflorescence and mold growth within the system.



Schluter®-Shower System

The Schluter®-Shower System is an integrated family of products that creates a “sealed” system. First, the Schluter®-KERDI-DRAIN is installed in conjunction with either a sloped mortar bed or the Schluter®-KERDI-SHOWER-ST prefabricated foam tray. The KERDI-DRAIN provides a simple and secure connection to the Schluter®-KERDI waterprooing membrane at the top of the assembly via the unique integrated bonding flange. Unlike shower pan liners in traditional assemblies, KERDI is a bonded waterprooing membrane that allows for the direct application of tile with thin-set mortar. KERDI is bonded to the mortar bed or tray and the surface of the KERDI-DRAIN's integrated bonding flange. In addition, KERDI is installed over the solid backing (e.g., gypsum board, cement backerboard, etc.) on walls, creating a fully waterproof and vapor-tight enclosure.

The resulting assembly provides superior moisture management as it does not permit moisture to penetrate into the mortar bed or solid backing, allowing the assembly to dry completely between uses. The integrated Schluter®-Shower System eliminates leaks, reduces the potential for efflorescence and mold growth in the system, and dramatically reduces total installation time to ensure success and make shower installation easier than ever.

CONTENTS

SHOWER ASSEMBLY	4	Prefabricated tray - Schluter®-KERDI-SHOWER-ST
	6	Mortar base
STEAM SHOWER ASSEMBLY	8	Schluter®-KERDI-SHOWER-ST or mortar base
BATHTUB SURROUND ASSEMBLY	10	Schluter®-KERDI
INSTALLATION	12	Shower assembly with prefabricated tray and curb
	14	Shower assembly with mortar base
	16	Bathtub surround assembly
BARRIER-FREE SHOWERS	17	Accessibility and style
THE WATERPROOF BATHROOM	18	Security and utility
PROFILES	20	Unleash your creativity
THIN-SET FACTS	22	Discussion on thin-set mortar types to be used with Schluter®-KERDI
TESTING, LISTINGS, & APPROVALS	23	Products and system evaluation
MOLD	24	The importance of mold control
VAPOR	25	The importance of water vapor management
PRODUCT & ORDERING INFO	26	
WARRANTY	31	



Schluter®-Systems' written installation instructions shall have precedence over referenced industry standard guidelines and installation procedures insofar as referenced information may contain overlapping or conflicting requirements. Type, thickness, and format of the tile or stone surface covering must be suitable for the intended application.

SHOWER ASSEMBLY

Beautiful, durable, and functional

The integrated Schluter®-Shower System eliminates leaks, reduces the potential for efflorescence and mold growth in the system, and dramatically reduces total installation time to ensure success and make shower installation easier than ever. Schluter® prefabricated EPS foam substrates provide a lightweight alternative to shower bases constructed of mortar and are especially useful in large-scale, repetitive jobs, such as hotels, apartments, and condominiums for the additional timesavings that can be realized.

Showers - Ceramic or stone tile

Prefabricated tray - Schluter®-KERDI-SHOWER-ST

K-SH-F-08

- 1 Ceramic or stone tile
- 2 Unmodified thin-set mortar
- 3 Schluter®-KERDI waterproofing membrane
- 4 Schluter®-KERDI-BAND waterproofing strips
- 5 Schluter®-KERDI-KERECK-F waterproofing corners
- 6 Schluter®-KERDI-SEAL-PS/-MV seals or Schluter®-KERDI-FIX sealant and bonding compound
- 7 Unmodified thin-set mortar
- 8 Solid backing
- 9 Schluter®-KERDI-DRAIN
- 10 Schluter®-KERDI-SHOWER-ST
- 11 Schluter®-KERDI-SHOWER-SC or built-up curb
- 12 Unmodified thin-set mortar
- 13 Wood or concrete subfloor
- 14 Schluter®-DILEX profile (optional)



Prefabricated tray - Schluter®-KERDI-SHOWER-ST

K-SH-F-08

Areas of application

- ▲ Interior showers
- ▲ Over wood or concrete subfloors
- ▲ Areas requiring disabled access / barrier-free applications; see page 17

Limitations

- ▲ Certain glass tiles may not be compatible with bonded waterproof membranes and/or may require special setting materials. Consult glass tile manufacturer and Schluter®-Systems for more information.
- ▲ Certain moisture-sensitive stones, e.g., green marble, or resin-backed tiles, may not be appropriate for use in wet areas such as showers or may require special setting materials. Consult stone supplier and Schluter®-Systems for more information.
- ▲ Do not use sawn lumber curbs on concrete subfloors subject to moisture migration.

Requirements

- ▲ Plywood, OSB, or concrete subfloor must be clean, even, and load bearing.
- ▲ Solid backing – gypsum wallboard, cementitious backer unit, fiber-cement underlayment, fiber-reinforced water-resistant gypsum backerboard/underlayment, coated glass mat water-resistant gypsum backerboard, portland cement mortar bed, concrete, or masonry
- ▲ Curb – Schluter®-KERDI-SHOWER-SC, concrete, masonry block, or sawn lumber sheathed with solid backing (see above)
- ▲ Schluter®-KERDI-DRAIN shall be properly supported.
- ▲ Schluter®-KERDI-DRAIN shall be connected to the waste line; use ABS cement for ABS drains, PVC cement for PVC drains, and a flexible or no-hub connector for stainless steel drains.
- ▲ Schluter®-KERDI waterproofing membrane shall be installed up to the height of the showerhead at minimum.
- ▲ Any protrusions through the KERDI membrane (e.g., showerhead, mixing valve, etc.) must be treated with Schluter®-KERDI-SEAL-PS and Schluter®-KERDI-SEAL-MV seals, Schluter®-KERDI-FIX, or equivalent sealant.
- ▲ When using the stainless steel Schluter®-KERDI-DRAIN casing, use Schluter®-KERDI-FIX to bond Schluter®-KERDI to the integrated bonding flange.

Substrate Preparation

- ▲ Verify that subfloor panels and solid backing are properly fastened to framing members.
- ▲ Any leveling of the subfloor must be done prior to installing Schluter®-KERDI-SHOWER-ST/-SC/-SR.

Solid Backing Materials

- ▲ Gypsum wallboard – ASTM C1396/C1396M
- ▲ Cementitious backer unit – ANSI A118.9 or ASTM C1325
- ▲ Fiber-cement underlayment – ASTM C1288
- ▲ Fiber-reinforced water-resistant gypsum backerboard/underlayment – ASTM C1278
- ▲ Coated glass mat water-resistant gypsum backerboard – ASTM C1178
- ▲ Portland cement mortar – ANSI A108.1B
- ▲ Concrete
- ▲ Masonry

Setting and Grouting Materials

- ▲ Unmodified thin-set mortar – ANSI A118.1
- ▲ Grout – ANSI A118.3, A118.6, A118.7

Installation Specifications

- ▲ Solid backing panels – follow manufacturer's instructions
- ▲ Portland cement mortar bed – ANSI A108.1B
- ▲ Tile – ANSI A108.5
- ▲ Grout – ANSI A108.6, A108.10

Other Considerations

- ▲ When Schluter®-KERDI-SHOWER-ST tray dimensions do not match the dimensions of the shower compartment, the tray may be cut or extended with portland cement mortar.
- ▲ When Schluter®-KERDI and tile are installed on the ceiling, the solid backing and fasteners must be able to support the load of the tile and setting/grouting materials.
- ▲ Prior to setting tile, wait 24 hours minimum before water testing to allow for final set of thin-set mortar and ensure waterproof performance at seams and connections.
- ▲ Schluter®-Systems profiles may be used to finish and protect outside corners and eliminate the use of sealant at inside corners; see pages 20-21.

SHOWER ASSEMBLY

Beautiful, durable, and functional

The integrated Schluter®-Shower System eliminates leaks, reduces the potential for efflorescence and mold growth in the system, and dramatically reduces total installation time to ensure success and make shower installation easier than ever. The Schluter®-KERDI-DRAIN integrates seamlessly with portland cement mortar beds to provide a sound base for the Schluter®-KERDI waterproofing membrane. Mortar bases can be formed in virtually any shape to allow for custom configurations of tiled showers.

Showers - Ceramic or stone tile

Mortar base

K-SH-M-08

- 1 Ceramic or stone tile
- 2 Unmodified thin-set mortar
- 3 Schluter®-KERDI waterproofing membrane
- 4 Schluter®-KERDI-BAND waterproofing strips
- 5 Schluter®-KERDI-KERECK-F waterproofing corners
- 6 Schluter®-KERDI-SEAL-PS/-MV seals or Schluter®-KERDI-FIX sealant and bonding compound
- 7 Unmodified thin-set mortar
- 8 Solid backing
- 9 Schluter®-KERDI-DRAIN
- 10 Portland cement mortar bed
- 11 Schluter®-KERDI-SHOWER-SC or built-up curb
- 12 Unmodified thin-set mortar
- 13 Wood or concrete subfloor
- 14 Schluter®-DILEX profile (optional)



Mortar base

K-SH-M-08

Areas of application

- ▲ Interior showers
- ▲ Over wood or concrete subfloors
- ▲ Areas requiring disabled access/ barrier-free applications; see page 17

Limitations

- ▲ Certain glass tiles may not be compatible with bonded waterproof membranes and/or may require special setting materials. Consult glass tile manufacturer and Schluter®-Systems for more information.
- ▲ Certain moisture-sensitive stones, e.g., green marble, or resin-backed tiles, may not be appropriate for use in wet areas such as showers or may require special setting materials. Consult stone supplier and Schluter®-Systems for more information.
- ▲ Do not use sawn lumber curbs on concrete subfloors subject to moisture migration.

Requirements

- ▲ Plywood, OSB, or concrete subfloor must be clean, even, and load bearing.
- ▲ Solid backing – gypsum wallboard, cementitious backer unit, fiber-cement underlayment, fiber-reinforced water-resistant gypsum backerboard/underlayment, coated glass mat water-resistant gypsum backerboard, portland cement mortar bed, concrete, or masonry
- ▲ Curb – Schluter®-KERDI-SHOWER-SC, concrete, masonry block, or sawn lumber sheathed with solid backing (see above)
- ▲ Schluter®-KERDI-DRAIN shall be properly supported.
- ▲ Schluter®-KERDI-DRAIN shall be connected to the waste line; use ABS cement for ABS drains, PVC cement for PVC drains, and a flexible or no-hub connector for stainless steel drains.
- ▲ Schluter®-KERDI waterproofing membrane shall be installed up to the height of the showerhead at minimum.
- ▲ Any protrusions through the KERDI membrane (e.g., showerhead, mixing valve, etc.) must be treated with Schluter®-KERDI-SEAL-PS and Schluter®-KERDI-SEAL-MV seals, Schluter®-KERDI-FIX, or equivalent sealant.
- ▲ When using the stainless steel Schluter®-KERDI-DRAIN casing, use Schluter®-KERDI-FIX to bond Schluter®-KERDI to the integrated bonding flange.

Substrate Preparation

- ▲ Verify that subfloor panels and solid backing are properly fastened to framing members.
- ▲ Any leveling of the subfloor must be done prior to installing Schluter®-KERDI-SHOWER-SC/-SR.

Solid Backing Materials

- ▲ Gypsum wallboard – ASTM C1396/C1396M
- ▲ Cementitious backer unit – ANSI A118.9 or ASTM C1325
- ▲ Fiber-cement underlayment – ASTM C1288
- ▲ Fiber-reinforced water-resistant gypsum backerboard/underlayment – ASTM C1278
- ▲ Coated glass mat water-resistant gypsum backerboard – ASTM C1178
- ▲ Portland cement mortar – ANSI A108.1B
- ▲ Concrete
- ▲ Masonry

Setting and Grouting Materials

- ▲ Unmodified thin-set mortar – ANSI A118.1
- ▲ Grout – ANSI A118.3, A118.6, A118.7

Installation Specifications

- ▲ Solid backing panels – follow manufacturer's instructions
- ▲ Portland cement mortar bed – ANSI A108.1B
- ▲ Tile – ANSI A108.5
- ▲ Grout – ANSI A108.6, A108.10

Other Considerations

- ▲ When Schluter®-KERDI and tile are installed on the ceiling, the solid backing and fasteners must be able to support the load of the tile and setting/grouting materials.
- ▲ Prior to setting tile, wait 24 hours minimum before water testing to allow for final set of thin-set mortar and ensure waterproof performance at seams and connections.
- ▲ Schluter®-Systems profiles may be used to finish and protect outside corners and eliminate the use of sealant at inside corners; see pages 20-21.

Schluter®-KERDI-SHOWER-ST or mortar base

K-SSH-08

Areas of application

- ▲ Interior steam showers
- ▲ Over wood or concrete subfloors
- ▲ Areas requiring disabled access/ barrier-free applications; see page 17

Limitations

- ▲ Certain glass tiles may not be compatible with bonded waterproof membranes and/or may require special setting materials. Consult glass tile manufacturer and Schluter®-Systems for more information.
- ▲ Certain moisture-sensitive stones, e.g., green marble, or resin-backed tiles, may not be appropriate for use in wet areas such as steam showers or may require special setting materials. Consult stone supplier and Schluter®-Systems for more information.
- ▲ Gypsum-based solid backing panels shall be limited in use to residential steam showers (i.e., no commercial steam rooms).
- ▲ Do not use sawn lumber curbs on concrete subfloors subject to moisture migration.

Requirements

- ▲ Plywood, OSB, or concrete subfloor must be clean, even, and load bearing.
- ▲ Provide insulation in wall and ceiling cavities to reduce moisture condensation on the tiled surface.
- ▲ Solid backing – gypsum wallboard, cementitious backer unit, fiber-cement underlayment, fiber-reinforced water-resistant gypsum backerboard/underlayment, coated glass mat water-resistant gypsum backerboard, portland cement mortar bed, concrete, or masonry
- ▲ Base – Schluter®-KERDI-SHOWER-ST or portland cement mortar bed
- ▲ Curb – Schluter®-KERDI-SHOWER-SC, concrete, masonry block, or sawn lumber sheathed with solid backing (see above)
- ▲ Schluter®-KERDI-DRAIN shall be properly supported.
- ▲ Schluter®-KERDI-DRAIN shall be connected to the waste line; use ABS cement for ABS drains, PVC cement for PVC drains, and a flexible or no-hub connector for stainless steel drains.
- ▲ Slope ceilings 2" per foot minimum to avoid condensation from dripping onto occupants (may be sloped to center to minimize rundown on walls).
- ▲ Install Schluter®-KERDI waterproofing membrane on all surfaces, including the ceiling.
- ▲ Any protrusions through the KERDI membrane (e.g., showerhead, mixing valve, steam inlet, etc.) must be treated with Schluter®-KERDI-SEAL-PS and Schluter®-KERDI-SEAL-MV seals, Schluter®-KERDI-FIX, or equivalent sealant.
- ▲ Movement joints shall be provided at all changes in plane, including floor/wall, wall/wall, and wall/ceiling transitions. Schluter®-Systems prefabricated movement joint profiles (e.g., Schluter®-DILEX-EKE) provide a maintenance-free alternative to sealant; see page 21.
- ▲ When using the stainless steel Schluter®-KERDI-DRAIN casing, use Schluter®-KERDI-FIX to bond Schluter®-KERDI to the integrated bonding flange.

Substrate Preparation

- ▲ Verify that subfloor panels and solid backing are properly fastened to framing members.
- ▲ Any leveling of the subfloor must be done prior to installing Schluter®-KERDI-SHOWER-ST/-SC/-SR.

Solid Backing Materials

- ▲ Gypsum wallboard – ASTM C1396/C1396M
- ▲ Cementitious backer unit – ANSI A118.9 or ASTM C1325
- ▲ Fiber-cement underlayment – ASTM C1288
- ▲ Fiber-reinforced water-resistant gypsum backerboard/underlayment – ASTM C1278
- ▲ Coated glass mat water-resistant gypsum backerboard – ASTM C1178
- ▲ Portland cement mortar – ANSI A108.1B
- ▲ Concrete
- ▲ Masonry

Setting and Grouting Materials

- ▲ Unmodified thin-set mortar – ANSI A118.1
- ▲ Grout – ANSI A118.6, A118.7

Installation Specifications

- ▲ Solid backing panels – follow manufacturer's instructions
- ▲ Portland cement mortar bed – ANSI A108.1B
- ▲ Tile – ANSI A108.5
- ▲ Grout – ANSI A108.6, A108.10

Other Considerations

- ▲ When Schluter®-KERDI and tile are installed on the ceiling, the solid backing and fasteners must be able to support the load of the tile and setting/grouting materials.
- ▲ Prior to setting tile, wait 24 hours minimum before water testing to allow for final set of thin-set mortar and ensure waterproof performance at seams and connections.
- ▲ Schluter®-Systems profiles may be used to finish and protect outside corners and eliminate the use of sealant at inside corners; see pages 20-21.

BATHTUB SURROUND

Beautiful, durable, and functional

The integrated Schluter®-Shower System eliminates leaks, reduces the potential for efflorescence and mold growth in the system, and dramatically reduces total installation time to ensure success and make bathtub surround installation easier than ever. The Schluter®-KERDI-BAND waterproofing strip is simply and easily adhered to the tub flange with the Schluter®-KERDI-FIX sealant and bonding compound to provide a watertight junction between the tub and Schluter®-KERDI waterproofing membrane on the walls.

Bathtub surround - Ceramic or stone tile

Schluter®-KERDI

K-TS-08

- 1 Ceramic or stone tile
- 2 Unmodified thin-set mortar
- 3 Schluter®-KERDI waterproofing membrane
- 4 Schluter®-KERDI-BAND waterproofing strips
- 5 Schluter®-KERDI-KERECK-F waterproofing corners
- 6 Schluter®-KERDI-SEAL-PS/-MV seals or Schluter®-KERDI-FIX sealant and bonding compound
- 7 Schluter®-KERDI-FIX sealant and bonding compound
- 8 Unmodified thin-set mortar
- 9 Solid backing
- 10 Schluter®-DILEX profile (optional)



Schluter®-KERDI

K-TS-08

Areas of application

- ▲ Interior bathtub surrounds

Limitations

- ▲ Certain glass tiles may not be compatible with bonded waterproof membranes and/or may require special setting materials. Consult glass tile manufacturer and Schluter®-Systems for more information.
- ▲ Certain moisture-sensitive stones, e.g., green marble, or resin-backed tiles, may not be appropriate for use in wet areas such as bathtub surrounds or may require special setting materials. Consult stone supplier and Schluter®-Systems for more information.

Requirements

- ▲ Solid backing – gypsum wallboard, cementitious backer unit, fiber-cement underlayment, fiber-reinforced water-resistant gypsum backerboard/underlayment, coated glass mat water-resistant gypsum backerboard, portland cement mortar bed, concrete, or masonry
- ▲ Solid backing panels shall be spaced a minimum of 1/4" (6 mm) above the lip of the tub.
- ▲ Schluter®-KERDI waterproofing membrane shall be installed up to the height of the showerhead at minimum.
- ▲ Any protrusions through the KERDI membrane (e.g., tub spout, showerhead, mixing valve, etc.) must be treated with Schluter®-KERDI-SEAL-PS and Schluter®-KERDI-SEAL-MV seals, Schluter®-KERDI-FIX, or equivalent sealant.

Substrate Preparation

- ▲ Verify that solid backing is properly fastened to framing members.

Solid Backing Materials

- ▲ Gypsum wallboard – ASTM C1396/C1396M
- ▲ Cementitious backer unit – ANSI A118.9 or ASTM C1325
- ▲ Fiber-cement underlayment – ASTM C1288
- ▲ Fiber-reinforced water-resistant gypsum backerboard/underlayment – ASTM C1278
- ▲ Coated glass mat water-resistant gypsum backerboard – ASTM C1178
- ▲ Portland cement mortar – ANSI A108.1B
- ▲ Concrete
- ▲ Masonry

Setting and Grouting Materials

- ▲ Unmodified thin-set mortar – ANSI A118.1
- ▲ Grout – ANSI A118.3, A118.6, A118.7

Installation Specifications

- ▲ Solid backing panels – follow manufacturer's instructions
- ▲ Portland cement mortar bed – ANSI A108.1B
- ▲ Tile – ANSI A108.5
- ▲ Grout – ANSI A108.6, A108.10

Other Considerations

- ▲ When Schluter®-KERDI and tile are installed on the ceiling, the solid backing and fasteners must be able to support the load of the tile and setting/grouting materials.
- ▲ Schluter®-Systems profiles may be used to finish and protect outside corners and eliminate the use of sealant at inside corners; see pages 20-21.

INSTALLATION

Shower assembly with prefabricated tray and curb

Please refer to the Schluter®-Systems installation video in addition to reading the instructions below.



- 1a** After locating the correct position for the drain, cut a hole in the substrate using KERDI-SHOWER-ST tray as a template. **Note:** A larger hole can lead to lack of support and damage the tile assembly (e.g., cracked grout around drain).

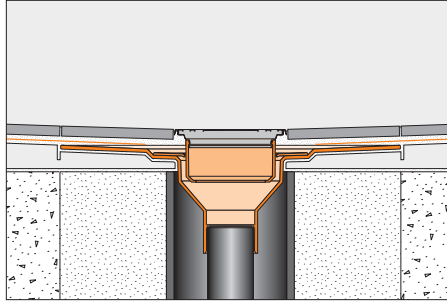

- 1b** Fill in box-outs in concrete floors with dry-pack mortar. A 4" (100 mm)-diameter plastic pipe coupling or similar can be used as a form around the waste line. Select form to accommodate the KERDI-DRAIN bonding flange. Limit the hole diameter to 5" (125 mm) maximum to ensure proper support of the tile assembly.



- 2** Apply unmodified thin-set mortar to the substrate using a 1/4" x 3/8" (6 mm x 10 mm) square- or U-notched trowel. The floor must be level. Any leveling must be done prior to placing the tray.

Note: When the Schluter®-KERDI-DRAIN must be installed prior to the Schluter®-KERDI-SHOWER-ST tray, see step 10b.



- 3** Place the KERDI-SHOWER-ST tray and solidly embed in the mortar.



- 4** Check the underside of the tray to ensure that full coverage and support are achieved.



- 5** Construct floor/wall and wall/ceiling* connections and seal vertical inside corners using the KERDI-BAND waterproofing strip or 5" (125 mm)-wide cut sections of KERDI waterproofing membrane. Install KERDI-KERECK-F pre-formed corners at inside corners.

*Applies when installing KERDI on the ceiling. KERDI application on ceiling is required for steam showers and optional for showers and tub surrounds.

Note: The KERDI-SHOWER-ST tray can be cut to size to fit various applications. Ideally, the tray should be cut by equal amounts on all four sides to ensure a consistent height of the first course of wall tile. The shower base can also be extended past the perimeter of the shower tray using dry-pack mortar.



- 6** Protect walls and ceiling* from moisture and vapor penetration using KERDI. Seams are constructed by overlapping the edges of KERDI by 2" (50 mm) minimum or by butting adjacent sheets of KERDI and installing KERDI-BAND, centered over the joint.

*Applies when installing KERDI on the ceiling. KERDI application on ceiling is required for steam showers and optional for showers and tub surrounds.



- 7** Install KERDI-SEAL-PS pipe seals at shower-head, body sprays, etc. and KERDI-SEAL-MV mixing valve seal at the mixing valve. As an alternative, KERDI-FIX or equivalent sealant can be used to seal pipe protrusions and protect moisture-sensitive solid backing panels at the mixing valve.



- 8** OPTION: Walls can be waterproofed with Schluter®-KERDI prior to the installation of tray. Floor/wall connections are constructed with Schluter®-KERDI-BAND after installing the tray.

KERDI, KERDI-BAND, KERDI-KERECK-F, KERDI-SEAL-PS, and KERDI-SEAL-MV are installed using unmodified thin-set mortar (mixed to a fairly fluid consistency, but still able to hold a notch). Dampen particularly dry and porous substrates in order to help prevent premature drying or skinning of the thin-set mortar. Apply the thin-set mortar using a 1/4" x 3/16" (6 mm x 5 mm) V-notched trowel or the Schluter®-KERDI trowel, which features a 1/8" x 1/8" (3 mm x 3 mm) square-notched design. Embed the membrane into the mortar throughout its entire surface to ensure proper adhesion and to remove air pockets. Periodically lift up a corner to check the fleece for full coverage. The sequence of membrane installation can vary provided that a minimum 2" (50 mm) overlap is maintained at all joints and proper connection to the KERDI-DRAIN is established. **Note:** Top-over-bottom or shingle laps of the membrane are not required.



9 If there is access to the plumbing from below and the waste line can be connected after installing the KERDI-DRAIN, apply unmodified thin-set mortar to the entire shower tray surface and completely fill the step in the shower tray.



10 a) The KERDI-DRAIN is pressed firmly into the thin-set mortar, ensuring full support of the bonding flange. b) When KERDI-DRAIN must be set by the plumber prior to the KERDI-SHOWER-ST tray (or when there is no access to the plumbing from below), the KERDI-DRAIN is connected to the waste line and set to the appropriate height using the detachable center section (1) of the tray or the foam spacers (2) included with the drain. Before installing the KERDI-SHOWER-ST tray, apply thin-set mortar to the substrate and to the top and bottom of the detached center section. Slide the center section into place below the drain to ensure solid and uniform support of the bonding flange.

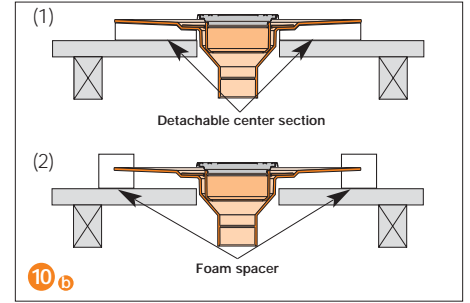

Note: Schluter®-Systems recommends installing the KERDI-SHOWER-ST tray prior to setting KERDI-DRAIN whenever possible. This allows greater control over the final position of the drain and makes it easier to obtain full support under the bonding flange.



11 When using the ABS or PVC drain, apply additional unmodified thin-set mortar to the top of the fleece-laminated bonding flange. When using the stainless steel drain, KERDI is adhered to the bonding flange with the KERDI-FIX adhesive/sealant. The stainless steel bonding flange must be clean and free of grease or other contaminants prior to KERDI-FIX application.



12 Embed the KERDI waterproofing membrane into the mortar and work the matting onto the entire surface of the tray to ensure proper adhesion and to remove air pockets. Be sure the connection between the KERDI and KERDI-DRAIN is secure.



13 If necessary, cut the KERDI-SHOWER-SC curb to length using a handsaw. Apply unmodified thin-set mortar to the floor and to the edge of the shower tray and walls using a 1/4" x 3/8" (6 mm x 10 mm) square- or U-notched trowel, and press the curb firmly into place. Check the underside of the curb to ensure that full coverage and support is achieved.



14 Use KERDI-KERECK-F pre-formed inside and outside corners to seal the shower curb to the walls and tray. The curb/tray junction is sealed using KERDI-BAND. Cover the curb with KERDI.



15 The KERDI waterproofing application is now complete. Prior to setting tile, wait 24 hours minimum before water testing to allow for final set of thin-set mortar and ensure waterproof performance at seams and connections. Before and during tile installation, the tray and KERDI must be protected in a suitable manner (e.g., cardboard can be laid over the floor to protect against mechanical damage). Using a trowel that is appropriate for the size of the tile, apply unmodified thin-set mortar directly to the exposed KERDI surface and install the tiles, ensuring full coverage.



16 The grate assembly is installed in conjunction with the tile. Place the height adjustment collar inside the lateral adjustment ring and snap the grate into place. Fill the step in the bonding flange with thin-set mortar and press the assembly into the mortar. The edges of the tile around the grate are back-buttered to ensure full support of the tile and lock the grate assembly in place. Position the grate to match the joint pattern of the tile covering and press flush with the tile surface. **Note:** Protect the visible surface of the grate from contact with setting and grouting materials. In particular, anodized aluminum is sensitive to alkaline materials.

INSTALLATION

Shower assembly with mortar base

Please refer to the Schluter®-Systems installation video in addition to reading the instructions below.



- 1a** After locating the correct position for the drain, cut a hole in the substrate using the template provided. **Note:** A larger hole can lead to lack of support and damage to the tile assembly (e.g., cracked grout around the drain).

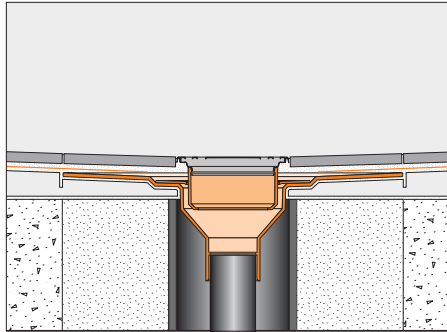

- 1b** Fill in box-outs in concrete floors with dry-pack mortar. A 4" (100 mm)-diameter plastic pipe coupling or similar can be used as a form around the waste line. Select form to accommodate the KERDI-DRAIN bonding flange. Limit the hole diameter to 5" (125 mm) maximum to ensure proper support of the tile assembly.



- 2** Place a mortar screed around the base of the shower.



- 3a** Place a ring of loose mortar up to the inlet hole in the floor and firmly press the drain into the mortar. The bonding flange must be fully supported to prevent damage to the tile assembly (e.g., cracked grout around drain).

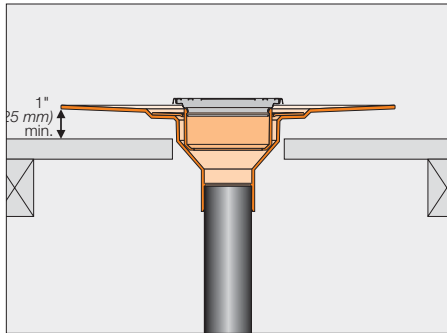

- 3b** When KERDI-DRAIN must be set by the plumber prior to the mortar bed (or when there is no access to the plumbing from below), the KERDI-DRAIN is connected to the waste line and set at the desired height. When installing KERDI-DRAIN over wood substrates, the minimum thickness of mortar required at the perimeter of the bonding flange is 1" (25 mm). Before installing the mortar bed, pack loose mortar under the drain up to the inlet hole to ensure solid and uniform support of the bonding flange.



- 4** Fill the remainder of the shower base with mortar. Slope the mortar bed using the bonding flange and the perimeter screed as a screeding guide. As soon as the mortar bed can be walked upon, waterproofing with the KERDI membrane can begin.

Note: Schluter®-Systems recommends installing the KERDI-DRAIN according to step 3a whenever possible. This allows greater control over the final position of the drain and makes it easier to obtain full support under the bonding flange.



- 5** Construct floor/wall and wall/ceiling* connections and seal vertical inside corners using the KERDI-BAND waterproofing strip or 5" (125 mm)-wide cut sections of KERDI waterproofing membrane. Install KERDI-KERECK-F pre-formed corners at inside corners.

*Applies when installing KERDI on the ceiling. KERDI application on ceiling is required for steam showers and optional for showers and tub surrounds.



- 6** Apply unmodified thin-set mortar to the shower base. When using the ABS or PVC drain, apply additional unmodified thin-set mortar to the top of the fleece-laminated bonding flange. When using the stainless steel drain, KERDI is adhered to the bonding flange with the KERDI-FIX adhesive/sealant. The stainless steel bonding flange must be clean and free of grease or other contaminants prior to KERDI-FIX application.



- 7** Apply the KERDI membrane to the entire surface of the mortar bed. The KERDI is carried to the step in the bonding flange (template provided). Be sure the connection between the KERDI and KERDI-DRAIN is secure.



8 Use KERDI-KERECK-F pre-formed inside and outside corners to seal the shower curb to the wall and mortar base. The curb/base junction is sealed using KERDI-BAND. Cover the curb with KERDI.



9 Protect walls and ceiling* from moisture and vapor penetration using KERDI. Seams are constructed by overlapping the edges of KERDI by 2" (50 mm) minimum or by butting adjacent sheets of KERDI and installing KERDI-BAND, centered over the joint.

*Applies when installing KERDI on the ceiling. KERDI application on ceiling is required for steam showers and optional for showers and tub surrounds.



10 Install KERDI-SEAL-PS pipe seals at shower-head, body sprays, etc. and KERDI-SEAL-MV mixing valve seal at the mixing valve. As an alternative, KERDI-FIX or equivalent sealant can be used to seal pipe protrusions and protect moisture-sensitive solid backing panels at the mixing valve.



11 The KERDI waterproofing application is now complete. Prior to setting tile, wait 24 hours minimum before water testing to allow for final set of thin-set mortar and ensure waterproof performance at seams and connections. Before and during tile installation, the KERDI on the mortar base must be protected in a suitable manner (e.g., cardboard can be laid over the floor to protect against mechanical damage). Using a trowel that is appropriate for the size of the tile, apply unmodified thin-set mortar directly to the exposed KERDI surface and install the tiles, ensuring full coverage.



12 The grate assembly is installed in conjunction with the tile. Place the height adjustment collar inside the lateral adjustment ring and snap the grate into place. Fill the step in the bonding flange with thin-set mortar and press the assembly into the mortar. The edges of the tile around the grate are back-buttered to ensure full support of the tile and lock the grate assembly in place. Position the grate to match the joint pattern of the tile covering and press flush with the tile surface.

Note: Protect the visible surface of the grate from contact with setting and grouting materials. In particular, anodized aluminum is sensitive to alkaline materials.

KERDI, KERDI-BAND, KERDI-KERECK-F, KERDI-SEAL-PS, and KERDI-SEAL-MV are installed using unmodified thin-set mortar (mixed to a fairly fluid consistency, but still able to hold a notch). Dampen particularly dry and porous substrates in order to help prevent premature drying or skinning of the thin-set mortar. Apply the thin-set mortar using a 1/4" x 3/16" (6 mm x 5 mm) V-notched trowel or the Schluter®-KERDI trowel, which features a 1/8" x 1/8" (3 mm x 3 mm) square-notched design. Embed the membrane into the mortar throughout its entire surface to ensure proper adhesion and to remove air pockets. Periodically lift up a corner to check the fleece for full coverage. The sequence of membrane installation can vary provided that a minimum 2" (50 mm) overlap is maintained at all joints and proper connection to the KERDI-DRAIN is established. Note: Top-over-bottom or shingle laps of the membrane are not required.

INSTALLATION

Bathtub surround assembly

Please refer to the Schluter®-Systems installation video in addition to reading the instructions below.



- 1 Place painter's tape to protect the tub deck. Construct tub/wall connections using the KERDI-BAND waterproofing strip or 5" (125 mm)-wide cut sections of KERDI waterproofing membrane. Apply unmodified thin-set mortar to solid backing and completely fill the 1/4" (6 mm)-wide gap between the solid backing and tub with KERDI-FIX or an equivalent sealant.

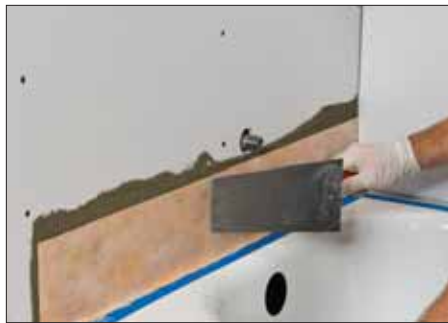

- 2 Solidly embed KERDI-BAND in the mortar and KERDI-FIX.



- 3 Protect walls and ceiling* from moisture and vapor penetration using KERDI. Apply unmodified thin-set mortar to walls and completely fill the 1/4" (6 mm)-wide gap between the solid backing and tub with KERDI-FIX or an equivalent sealant.

*Applies when installing KERDI on the ceiling. KERDI application on ceiling is required for steam showers and optional for showers and tub surrounds.



- 4 Solidly embed KERDI in the mortar and KERDI-FIX.



- 5 Seams are constructed by overlapping the edges of KERDI by a minimum of 2" (50 mm) or by butting adjacent sheets of KERDI and installing KERDI-BAND with unmodified thin-set mortar, centered over the joint.



- 6 Install KERDI-BAND at inside wall corners and wall/ceiling junctions* using unmodified thin-set mortar, centered over the joints. Install KERDI-KERECK-F pre-formed corners at inside corners.

*Applies when installing KERDI on the ceiling. KERDI application on ceiling is required for steam showers and optional for showers and tub surrounds.



- 7 Install KERDI-SEAL-PS pipe seals at tub spout, showerhead, body sprays, etc. and KERDI-SEAL-MV mixing valve seal at the mixing valve. As an alternative, KERDI-FIX or equivalent sealant can be used to seal pipe protrusions and protect moisture-sensitive solid backing panels at the mixing valve.

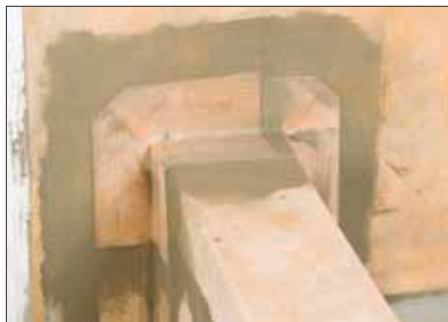

- 8 Seal connections to knee walls using KERDI-KERECK-F preformed outside corners and unmodified thin-set mortar.



- 9 The KERDI waterproofing application is now complete. Apply unmodified thin-set mortar directly to the exposed KERDI surface and install the tiles, ensuring full coverage.

KERDI, KERDI-BAND, KERDI-KERECK-F, KERDI-SEAL-PS, and KERDI-SEAL-MV are installed using unmodified thin-set mortar (mixed to a fairly fluid consistency, but still able to hold a notch). Dampen particularly dry and porous substrates in order to help prevent premature drying or skinning of the thin-set mortar. Apply the thin-set mortar using a 1/4" x 3/16" (6 mm x 5 mm) V-notched trowel or the Schluter®-KERDI trowel, which features a 1/8" x 1/8" (3 mm x 3 mm) square-notched design. Embed the membrane into the mortar throughout its entire surface to ensure proper adhesion and to remove air pockets. Periodically lift up a corner to check the fleece for full coverage. The sequence of membrane installation can vary provided that a minimum 2" (50 mm) overlap is maintained at all joints and proper connection to the KERDI-DRAIN is established. Note: Top-over-bottom or shingle laps of the membrane are not required.

BARRIER-FREE SHOWERS

Accessibility and style



As our population ages, there is increasing demand for accessible living spaces. Tiled showers typically feature curbs to retain water in the stall, which can make entry difficult for those with limited mobility, including individuals who need the assistance of wheelchairs. Barrier-free tiled showers eliminate the use of a curb and rely on the slope of the floor to keep water inside the stall, thus improving accessibility. These showers have also become increasingly popular for their aesthetic benefits, as they can integrate seamlessly with surrounding tiled surfaces to enhance an already luxurious environment.

DESIGN AND INSTALLATION CONSIDERATIONS

The Schluter®-Shower System provides a simple and effective means of waterproofing barrier-free installations. The key to this is that the Schluter®-KERDI waterproofing membrane is typically applied. Once the slope to drain is established, KERDI and tile are installed, thus minimizing the thickness of the assembly.

Barrier-free tiled showers rely on the slope of the floor to effectively contain water in the immediate shower area and direct water to the drain. Given the wide range of potential configurations, it isn't possible to address them all in this Handbook. However, the following guidelines will assist in planning any barrier-free installation.

Ideally, the floor will be recessed before installing a sloped mortar bed or the Schluter®-KERDI-SHOWER-ST shower tray to allow an even transition at the door threshold. This can be relatively straightforward in new construction and can also be accomplished in renovations. When recessing the floor is not an option, it is necessary to provide a ramp up into the shower area. The Schluter®-KERDI-SHOWER-ST/SR tray and ramp can be useful tools in such applications as well.

Please note that recessing the floor of a bathroom must be done in a way that preserves the structural integrity and safety of the construction. This may require the services of a qualified design professional (e.g., architect, engineer, etc.).

Waterproofing must be installed in all areas subject to water exposure. Ideally, the entire floor is protected. Install Schluter®-KERDI over mortar beds and Schluter® prefabricated EPS foam substrates. Use the Schluter®-DITRA uncoupling membrane over plywood/OSB or concrete subfloors. All seams are sealed using Schluter®-KERDI-BAND. Please see page 18 for further discussion.

Note on Accessibility Guidelines:

Various building codes and other sources, such as the Americans with Disabilities Act, include specific requirements for disabled access in public buildings and should be consulted when applicable. Areas of interest may include degree of slope, clearance, and supporting structures such as grab bars.

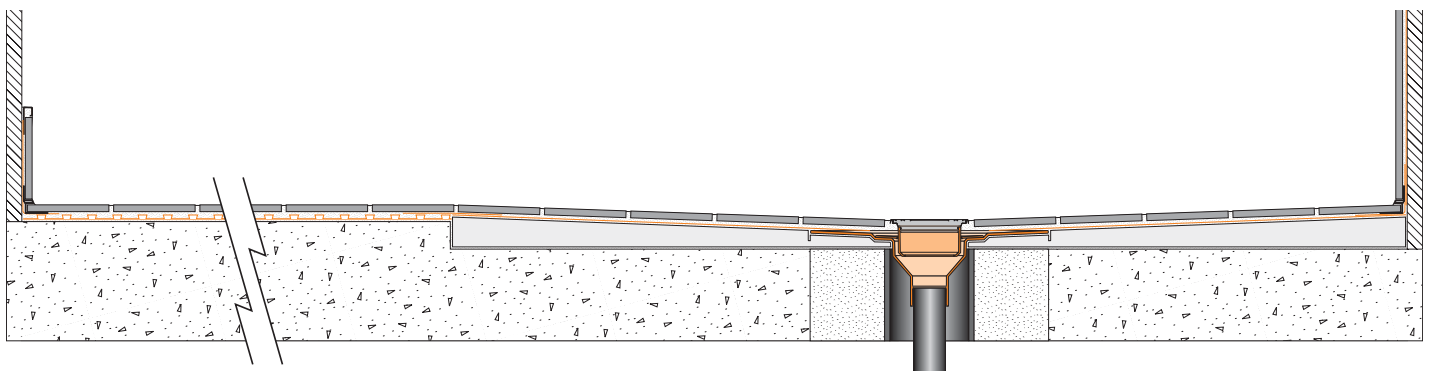

THE WATERPROOF BATHROOM

Security and utility



Bathrooms are a primary focus of today's building and remodeling projects and are becoming more and more luxurious, complete with steam showers, oversized bathtubs, and the latest in fixtures and lighting. As such, tiled showers, bathtub surrounds, floors, walls, and vanities are in high demand. Tile and stone are beautiful, durable, and available in a wide range of formats, colors, and textures, allowing limitless design options. Tile and stone offer unmatched utility and high-end appeal, making them the ideal surface coverings for bathrooms. Given the substantial investments made in these projects and nature of use, long-term durability is a high priority.

Waterproofing is the foundation of successful tiled bathrooms. Moisture-sensitive construction materials (e.g., wood framing, plywood and OSB sheathing, gypsum wallboard, etc.) are common in the North American building environment and must be protected in wet areas. Wet areas also bring the potential for mold growth if effective moisture management is not provided. The key to mold control is moisture control.



In addition to showers and tub surrounds, bathroom floors surrounding these fixtures are routinely subjected to water exposure during use. Bathroom floors may also, through unexpected circumstances, become exposed to significant amounts of water; for example, an overflowed toilet or ruptured sink supply, which can result in flooding. Water-proofing these floors can save an owner from replacing the tile assembly and substructure in the event of a leak.

Schluter®-Systems offers simple and effective solutions to protect moisture-sensitive substrates, prevent mold growth, and preserve the integrity of the tiled surface throughout the bathroom. The Schluter®-Shower System is an integrated family of products that together form a fully bonded, watertight assembly for tiled showers and bathtub surrounds. Schluter®-DITRA is an uncoupling membrane that protects the tiled floors from damage by neutralizing differential movement stresses between the substrate and tile and provides reliable waterproofing. Since both of these systems are based on topically-applied, bonded waterproof membranes, they can be combined simply and easily to provide waterproofing throughout the bathroom.



Floors can be made fully waterproof with Schluter®-DITRA. Since the membrane is made of waterproof polyethylene, the only extra step necessary is to seal the seams and floor/wall connections with KERDI-BAND. The same practice is used to integrate the DITRA with the Schluter®-KERDI used to waterproof the shower or tub surround. The result is a comprehensive waterproofing system that protects against moisture penetration.

Schluter®-KERDI and Schluter®-DITRA meet the requirements of the American National Standard for Load Bearing, Bonded, Waterproof Membranes for Thin-Set Ceramic Tile and Dimension Stone Installations (ANSI A118.10), are listed by cUPC®, and are evaluated by ICC-ES (see Report No. ESR-2467). Please consult the Schluter®-DITRA Installation Hand-book for comprehensive installation guidelines and warranty criteria.



Schluter®-DITRA Installation Handbook

The Schluter®-DITRA Installation Handbook contains complete details and illustrations for tile installations over various substrates, and supplementary information on topics such as waterproofing, movement joints, and thin-set mortars.

To obtain or download a free copy of the DITRA Installation Handbook, visit www.schluter.com or call 1-800-472-4588 (US) or 1-800-667-8746 (CAN).

PROFILES

Unleash your creativity



Finishing and edge protection

Ceramic and stone tiles are durable, easy to maintain, and hygienic, representing the ideal surface coverings for showers and bathtub surrounds. Exposed tile edges, however, are unsightly and prone to cracking and chipping. While ceramic trim pieces such as bullnose or quarter round have traditionally been used to finish and protect tile edges at the outside corners and perimeters of an installation, ceramic trim availability can be limited, particularly in imported tile lines, which can in turn limit overall tile selection.

Schluter®-Systems offers various finishing and edge-protection profiles for outside corners and other tiled edges that can be used with any field tile, thus reducing dependence on ceramic trim and increasing design options. These profiles are available in a wide range of materials and finishes such as stainless steel, anodized aluminum, brass, and colored PVC to produce a variety of looks, including bold contrasts, discreet color matches to the grout, and complements to plumbing fixtures.

1 Schluter®-RONDEC

Provides a symmetrically rounded edge for a smooth design. Matching inside and outside corners (90°), which eliminate mitered corners and provide a professional finished look, are available.

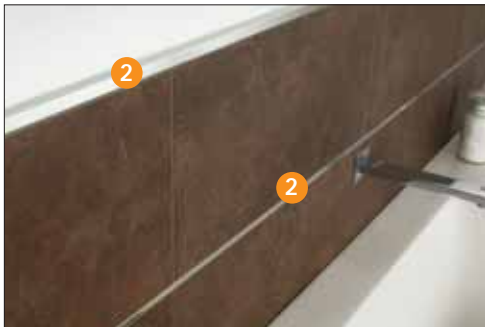
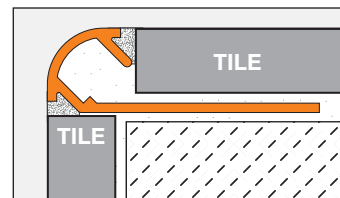

2 Schluter®-QUADEC

Provides a square edge for a contemporary and sleek design. QUADEC can also be used to produce decorative designs within the tile field. Matching inside and outside corners (90°) are available.

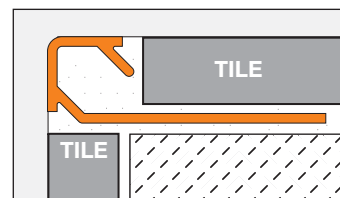

3 Schluter®-SCHIENE/JOLLY

Provides finishing and edge protection with a discreet straight edge. Corners are not available.

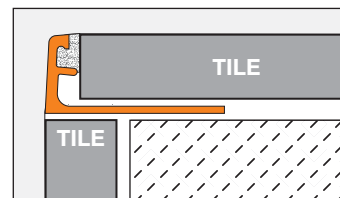

Color Reference



Finish Reference



Note: Colors and finishes referenced are not available for all products. Please see the Schluter®-Systems Illustrated Price List or visit www.schluter.com for more information on available materials, finishes, and sizes.

Maintenance-free inside corners

Ceramic cove base represents a neat, hygienic method for treating transitions at inside corners by providing a curved surface that prevents the collection of dirt and is easy to clean. However, the limited availability of ceramic trim pieces has resulted in the use of sealant and caulk to treat such transitions. These joints must be continually maintained throughout the life of the installation. This may include replacing the joints, which requires cutting the sealant out and possibly compromising the waterproofing membrane.

Schluter®-Systems offers various cove-shaped profiles to address the need to finish inside corners. These profiles can be used with any field tile to produce permanent, easy to clean, and maintenance-free floor/wall transitions and inside wall corners.

1 Schluter®-DILEX-AHK/-EHK/-HKW

These cove-shaped profiles allow for easy cleaning and will not trap debris, making them ideal for areas where strict hygiene is essential, such as tiled showers and bathtub surrounds. These profiles are available in a wide range of materials and finishes such as stainless steel, anodized aluminum, brass, and colored PVC to produce a variety of looks, including bold contrasts, discreet color matches to the grout, and compliments to plumbing fixtures. Matching inside and outside corners (90°) and end caps are available with these profiles. The prefabricated corners eliminate mitered corners and provide a professional finished look.



AHK (Anodized aluminum)

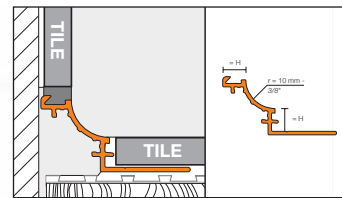

EHK (Stainless steel)

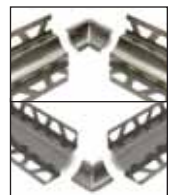
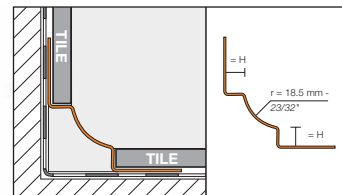

HKW (PVC)

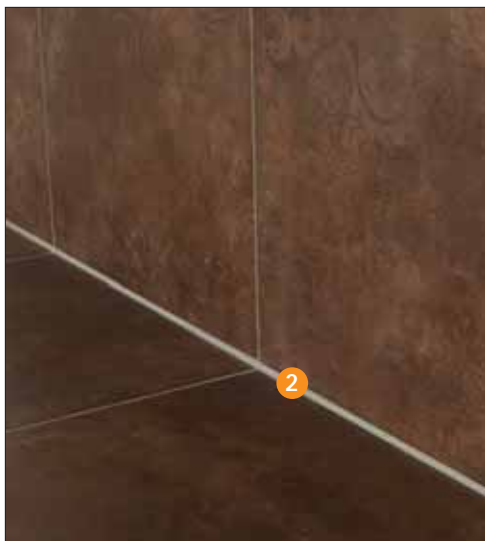
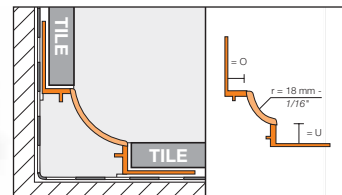

2 Schluter®-DILEX-EKE

Provides a straight, uniform, and discreet joint that eliminates sealant at inside corners. Available in a variety of colors to match the grout.

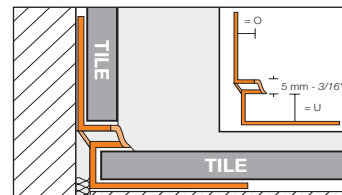

Note: Colors and finishes referenced are not available for all products. Please see the Schluter®-Systems Illustrated Price List or visit www.schluter.com for more information on available materials, finishes, and sizes.

THIN-SET FACTS

Discussion on thin-set mortars and Schluter®-KERDI installations



QUESTION

Should a latex-modified thin-set mortar or an unmodified thin-set mortar be used to install Schluter®-KERDI?

ANSWER

The type of bonding mortar used to apply Schluter®-KERDI must be suitable for the substrate and mechanically anchor the fleece on the KERDI. For all the substrates listed in this Handbook (e.g., gypsum board, cement backerboard, etc.), an unmodified thin-set mortar is recommended. When installing KERDI with unmodified thin-set mortar over particularly dry and porous substrates, it is recommended to wet the substrate first, in order to help prevent premature drying or skinning of the thin-set mortar.

Unmodified thin-set mortar must be used to construct all KERDI seams to ensure watertight performance of the system.

QUESTION

Can ceramic tile, including porcelain tile, be set on Schluter®-KERDI with unmodified thin-set mortar?

ANSWER

YES. In fact, we recommend it. Here's why:

Portland cement-based unmodified thin-set mortars are dependent on the presence of moisture for hydration in order to gain strength. Since Schluter®-KERDI is impervious, it does not deprive the mortar of its moisture. This allows the cement to properly hydrate, resulting in a strong, dense bond coat. In fact, after the mortar has reached final set (usually within 24 hours), unmodified thin-set mortars achieve higher strengths when cured in continually moist conditions.

QUESTION

Can ceramic tile, including porcelain tile, be set on Schluter®-KERDI with latex-modified thin-set mortar?

ANSWER

We DON'T recommend it. Here's why:

Latex-modified mortars must air dry for the polymers to coalesce and form a hard film in order to gain strength. When sandwiched between two impervious materials such as Schluter®-KERDI and ceramic tile, including porcelain tile, drying takes place very slowly through the open joints in the tile covering. [According to the Tile Council of North America's Handbook for Ceramic Tile Installation, this drying period can fluctuate from 14 days to over 60 days, depending on the geographic location, the climatic conditions, and whether the installation is interior or exterior]. Therefore, extended cure times would be required before grouting if using modified thin-set mortars between KERDI and ceramic tile, including porcelain tile. If extended cure times were not observed, the results could be unpredictable. This is even more important to consider in wet areas such as showers, as there is the additional concern of latex leaching.

ADDITIONAL NOTES

20 years of field experience and testing by the Tile Council of North America (TCNA) support the efficacy of using unmodified thin-set mortars in conjunction with Schluter®-KERDI in tiled showers.

Remember, all thin-set mortars have an acceptable temperature range that must be observed during application and curing.

TESTING, LISTINGS, & APPROVALS

Products and system evaluation

Schluter®-Systems is committed to providing reliable installation systems for tile and stone. As part of this commitment, we have invested considerable resources in testing our products and obtaining listings and approvals through various certification organizations to provide our customers and local code officials with relevant data that supports the efficacy of our system.

TEST DATA

Schluter®-KERDI has been independently tested and found to meet or exceed the requirements of the American National Standard Specifications for Load Bearing, Bonded, Waterproof Membranes for Thin-set Ceramic Tile and Dimension Stone Installation A118.10.

Property	Test method	Requirement	Performance
Fungus and micro-organism resistance		The membrane shall not support mold growth	Pass
Seam strength	ASTM D751	16 lb/2 in width	36 lb/2 in width
Breaking strength	ASTM D751	170 psi	1084 psi
Dimensional stability	ASTM D1204	0.7% maximum length change	Pass
Waterproofness	ASTM D4068	No moisture penetration	Pass
7-day shear strength	ASTM C482	50 psi	87 psi
7-day water immersion shear strength	ASTM C482	50 psi	77 psi
4-week shear strength	ASTM C482	50 psi	96 psi
12-week shear strength	ASTM C482	50 psi	90 psi
100-day water immersion shear strength	ASTM C482	50 psi	120 psi

Schluter®-KERDI has also been independently tested to determine the water vapor permeance of the product. Please see further discussion on the importance of water vapor permeance on page 25.

Property	Test method	Performance
Water vapor permeance	ASTM E96	0.75 perms

PRODUCT EVALUATIONS AND LISTINGS

Schluter®-Systems has obtained product evaluations and listings for Schluter®-KERDI and Schluter®-KERDI-DRAIN through various accredited organizations, including the International Code Council Evaluation Service (ICC-ES), the International Association of Plumbing and Mechanical Officials (IAPMO), CSA International, and NSF International.

Schluter®-KERDI

- ICC-ES Report No. ESR-2467
- Listed by cUPC® to meet ANSI A118.10

Schluter®-KERDI-DRAIN*

- Listed by UPC® to meet IGC 195
- Certified by CSA to meet CSA B79
- Certified by NSF as a special engineered product to meet applicable requirements of ASME A112.6.3

*Schluter®-KERDI-DRAIN is available in various configurations. Please refer to page 27 for information regarding which configurations are listed and certified.

APPROVALS

Schluter®-Systems has also participated in statewide approval programs where such programs are available.

Schluter®-Shower System

- Massachusetts
- Michigan
- Kentucky

Copies of the aforementioned test reports, listings, and approvals are available upon request. Listings and approvals may also be accessed via our website at www.schluter.com.

MOLD

The importance of mold control

The term “mold” is used to describe visible fungal growth. Mildew is another common term which refers to the type of fungi found growing on window sills and in bathrooms. Fungi are everywhere in our environment and are found both indoors and outdoors. However, the type and amount found in the home can be an important health issue. Understanding how to effectively control mold growth is very important.

What is Mold?

Fungi are different from plants and animals. Fungi cannot produce their own nutrients as plants do and reproduce differently than both plants and animals. Molds reproduce by making spores which travel through the air to deposit on surfaces. If the conditions are right for reproduction they can grow and continue to multiply. The filamentous parts of mold attach to nutrients and form networks called mycelia. It is these networks that are visible to us in the indoor environment. Molds come in a variety of colors, but we commonly see them as green or black.

Over 1000 different species of mold have been identified in homes, but they are not all toxic to humans. Molds growing inside a home may release chemicals and spores and some may even produce mycotoxins. The chemicals released by fungi are called volatile organic compounds (VOC). For example, ethanol is a common VOC that is responsible for the distinctive musty or earthy odor associated with mold.

Health Effects

Mold can cause damage to building materials and may have adverse health effects on some individuals. The susceptibility of people to develop symptoms depends on the nature of the fungal material, genetic predisposition, age, state of health, and extent of exposure. Although there is insufficient evidence in the scientific community to determine with certainty the association between mold exposure and the effect on human health, it is of course recommended to control mold exposure in the home and workplace. Common health effects associated with exposure to mold are a variety of upper and lower respiratory tract symptoms: cough; nose, throat and eye irritation; rhinitis; sneezing; and wheezing. These symptoms are similar to allergies and associated with asthma. Mycotoxins are fungal metabolites that have a toxic effect on humans. Toxic effects are associated with symptoms such as fever, nausea, headaches, and skin irritations.

Factors for Mold Growth

Fungi need a source of moisture, organic material to serve as a source of nutrients, and a warm environment with a temperature range from 50 to 107 °F (10 to 42 °C) to grow. For most species of fungi, a neutral to acidic pH is preferred, with a high pH level indicating an alkaline environment that is generally not conducive to mold growth. Mold will reproduce in such conditions as long as moisture is present. Once the area is dry, the mold may stop reproducing but can continue to be allergenic to susceptible people. If moisture is reintroduced, the mold will again start the reproduction cycle and grow.

Controlling Mold Growth

As stated above, four conditions must be satisfied to support mold growth.

1. Mold spores
2. Food source (organic material)
3. Warm temperatures: 50 to 107 °F (10 to 42 °C)
4. Moisture

Mold spores travel through the air indoors and outdoors and are impossible to eliminate. The use of organic materials in construction is common in today's building environment. Examples include wood framing members (e.g., studs, joists, I-joists, and trusses), plywood or OSB subfloors, paper-faced gypsum boards on walls and ceilings, etc. Room temperature falls within the temperature range suitable for mold growth. Therefore, the control of moisture, including liquid water and water vapor, is the only viable method for controlling mold growth in the indoor environment.

Showers are critical areas with respect to mold and moisture control. They are commonly exposed to thousands of gallons of water per year and high humidity levels. The tile covering alone will not prevent water and moisture penetration. As such, it is essential that an effective moisture management system be designed and installed properly to protect surrounding building materials and prevent mold growth.

The traditional method for installing tiled shower assemblies creates a water in/ water out system. Since shower pan liners are placed below the mortar setting bed in these assemblies, moisture is allowed to saturate the mortar bed before exiting the system through the weep holes in the drain. When the pan liner is placed on a level substrate instead of a sloped surface, a relatively common error, moisture in the system will have no means to exit through the weep holes in the drain and the mortar bed will remain saturated for extended periods of time. The continued presence of moisture, combined with organic materials carried into the mortar bed by the rinse water, warm temperatures, and reduced pH as soluble salts are washed out of the mortar bed, increases the risk of mold growth within the system.

The Schluter®-Shower System is an integrated family of products that creates a sealed system. Schluter®-KERDI is a bonded waterproof membrane that is installed on top of the mortar bed and solid backing on walls. Tile is installed directly over the membrane using thin-set mortar. The Schluter®-KERDI-DRAIN was designed specifically to ensure a simple and secure connection to bonded waterproof membranes, such as KERDI, at the top of the assembly rather than below it. The resulting assembly does not permit moisture penetration into the solid backing or mortar bed, thus limiting the amount of water behind the tile covering and allowing the shower to dry out between uses. Furthermore, Schluter®-KERDI is a vapor retarder that protects wall cavities from water vapor penetration. Thus, the Schluter®-Shower System provides superior moisture management and reduces the potential for mold growth within the system.

Regardless of the system used to waterproof a tiled shower, it is important to provide adequate ventilation (e.g., exhaust fans) in the bathroom to effectively manage water vapor and reduce condensation on all bathroom surfaces.

Further discussion and recommendations for mold remediation can be found in various sources, including the following.

- “A Brief Guide to Mold, Moisture, and Your Home” – U.S. Environmental Protection Agency (EPA)
- “Mold Remediation in Schools and Commercial Buildings” – U.S. Environmental Protection Agency (EPA)
- “Mould Guidelines for the Canadian Construction Industry” – Canadian Construction Association

VAPOR

The importance of water vapor management



Why is water vapor management important?

It is important to consider that water exists as both liquid and vapor in showers, and must be managed in both forms. The prime example of this is the steam shower. Steam showers that are not designed to manage water vapor have caused mold growth in wall cavities, rot in wood framing, and damage to moisture-sensitive wall coverings on the opposite side of the stud cavities.

Do all waterproofing membranes manage water vapor?

The ANSI A118.10 standard for bonded waterproof membranes was developed to provide a framework for determining the suitability of these products to serve as barriers to positive liquid water migration only. As such, the standard does not include a minimum criterion to establish the ability of products to limit vapor transmission. Thus, simply selecting a membrane that meets the requirements of the ANSI A118.10 standard for a steam shower application is not enough. The ability of the product to limit vapor transmission must be considered as well.

How can I identify a waterproofing membrane that manages water vapor?

Water vapor permeance is a measure of how quickly water vapor is transmitted through a material and can be determined according to the ASTM E96 Standard Test Method for Water Vapor Transmission of Materials. The higher the vapor permeance, the less effective a material is at slowing vapor transmission. Materials with a water vapor permeance of 1.0 perm or lower are generally considered to be vapor retarders and will manage vapor effectively in showers and steam showers.

Does Schluter®-KERDI manage water vapor?

The vapor permeance of Schluter®-KERDI, as measured per ASTM E96, is 0.75 perms. Thus, this product functions as both a waterproofing membrane and vapor retarder to manage water vapor in showers and steam shower applications.

PRODUCT & ORDERING INFO

The ordering information for the **Schluter®-Shower System** and **Schluter®-DITRA** components outlined in this Handbook is located below. For technical support, our Illustrated Price List, or additional information on our complete product line, please call **1-800-472-4588 (USA)** or **1-800-667-8746 (Canada)**, or visit our comprehensive web site at **www.schluter.com**.

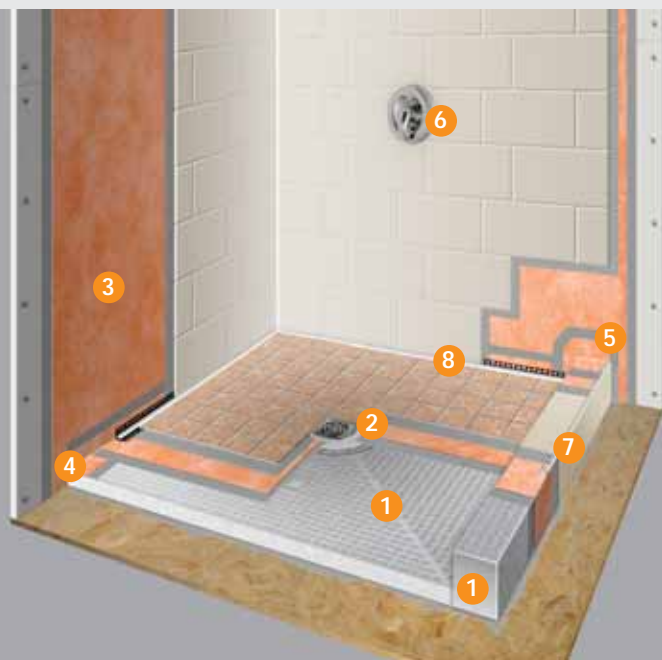

- 1 Schluter®-KERDI-SHOWER-ST/-SC**
Prefabricated tray and curb
- 2 Schluter®-KERDI-DRAIN**
Floor drain with a sloped, integrated bonding flange
- 3 Schluter®-KERDI**
Waterproofing membrane
- 4 Schluter®-KERDI-BAND**
Waterproofing strip
- 5 Schluter®-KERDI-KERECK-F**
Pre-formed inside and outside corners
- 6 Schluter®-KERDI-SEAL-PS/-MV**
Pipe and mixing valve seals
- 7 Schluter®-QUADEC/-RONDEC/-SCHIENE/-JOLLY**
Finishing and edge-protection profiles (Details on page 20)
- 8 Schluter®-DILEX**
Cove-shaped profiles (Details on page 21)

1 Schluter®-KERDI-SHOWER-ST/-SC/-SR

Schluter®-Systems' prefabricated shower substrates provide an alternative to bases constructed of mortar. The KERDI-SHOWER-ST tray is sloped and specifically designed to accept the KERDI-DRAIN. The KERDI-SHOWER-SC curb can be used with KERDI-SHOWER-ST tray or mortar applications. The KERDI-SHOWER-SR ramp is designed to facilitate the construction of access ramps for tiled showers.

Note: Prefabricated shower substrates can be cut to size to fit various applications. Ideally, the tray should be cut by equal amounts on all four sides to ensure a consistent height of the first course of wall tile. The shower base can also be extended past the perimeter of the shower tray using dry pack mortar.

Unique Features and Benefits:

- Made of lightweight expanded polystyrene.

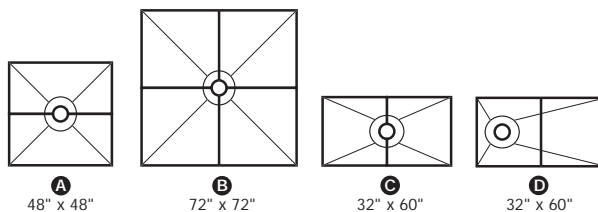

Note: Tray 4 features off-center drain placement: 10" (25.4 cm) o.c. from end of tray.



KERDI-SHOWER-ST
KERDI-SHOWER-SC

Schluter®-KERDI-SHOWER-ST				
Tray				
Item No.	Dimensions	Perimeter height	Drain placement	
A ST-122	48" x 48" - 122 cm x 122 cm	1-1/2" - 3.8 cm	center	
B ST-183	72" x 72" - 183 cm x 183 cm	1-1/2" - 3.8 cm	center	
C ST-81/152	32" x 60" - 81 cm x 152 cm	1-3/4" - 4.4 cm	center	
D ST-81/152 BR	32" x 60" - 81 cm x 152 cm	1-1/2" - 3.8 cm	off-center	

Schluter®-KERDI-SHOWER-SC	
Curb	
Item No.	Dimensions
SC-122	48" x 6" x 4-1/2" (122 cm x 15 cm x 11.5 cm)



KERDI-SHOWER-SR

Schluter®-KERDI-SHOWER-SR	
Ramp	
Item No.	Dimensions
SR-122	48" x 15-7/8" (122 cm x 40 cm)







2 Schluter®-KERDI-DRAIN

Schluter®-KERDI-DRAIN is a floor drain designed with a sloped, integrated bonding flange to provide a secure connection to KERDI and other bonded waterproof membranes at the top of the assembly.

Unique Features and Benefits:

- Appropriate for both mortar bed and KERDI-SHOWER-ST tray installations.
- Features a fully adjustable square grate and accommodates a wide range of tile thicknesses 1/4" to 1-1/4" (6 mm to 31 mm). Grate is available in stainless steel (E), brushed brass anodized aluminum (AMGB), brushed copper/bronze anodized aluminum (AKGB), and brushed nickel anodized aluminum (ANIGB).
- Ideal for new construction and renovation work.
- Saves installation time and labor, as it eliminates the prep work required for a traditional two-step mortar pan.



Schluter®-KERDI-DRAIN						
	4" (100 mm) Square Grate				6" (150 mm) Square Grate Round Grate	
						
	Stainless steel (E)	Brushed brass anod. alu. (AMGB)	Brushed copper/bronze anod. alu. (AKGB)	Brushed nickel anod. alu. (ANIGB)	Stainless steel (E)	Stainless steel (E)
A Floor drain, with integrated bonding flange with 2" (50 mm) outlet						
ABS	KD2/ABS/E ¹	KD2/ABS/AMGB ¹	KD2/ABS/AKGB ¹	KD2/ABS/ANIGB ¹	KD2/ABS/6E	KD2/ABS/6RE
PVC	KD2/PVC/E ¹	KD2/PVC/AMGB ¹	KD2/PVC/AKGB ¹	KD2/PVC/ANIGB ¹	KD2/PVC/6E	KD2/PVC/6RE
B Floor drain, with integrated bonding flange with 3" (75 mm) outlet						
ABS	-	-	-	-	KD3/ABS/6E	KD3/ABS/6RE
PVC	-	-	-	-	KD3/PVC/6E	KD3/PVC/6RE
C Floor drain, with integrated bonding flange with 3" (75 mm) no-hub outlet						
Stainless steel	KD3/E/E ²	KD3/E/AMGB	KD3/E/AKGB	KD3/E/ANIGB	KD3/E/6E ²	KD3/E/6RE ²
D Floor drain adaptor kit with stainless steel integrated bonding flange *						
Stainless steel	KDA/E/E	KDA/E/AMGB	KDA/E/AKGB	KDA/E/ANIGB	KDA/E/6E	KDA/E/6RE
E Floor drain adaptor kit with ABS integrated bonding flange *						
ABS	KDA/ABS/E	KDA/ABS/AMGB	KDA/ABS/AKGB	KDA/ABS/ANIGB	KDA/ABS/6E	KDA/ABS/6RE

¹ Listed by UPC®, CSA, and NSF.

² Listed by UPC®.

* Patent Pending

3 Schluter®-KERDI

Schluter®-KERDI is a pliable sheet-applied polyethylene waterproofing membrane and vapor retarder that guarantees uniform thickness. It is covered on both sides with a fleece webbing to anchor the membrane in thin-set mortar. Schluter®-KERDI is ideal for waterproofing floors and walls, including steam showers.

Unique Features and Benefits:

- Easy to install; hangs as effortlessly as wallpaper
- Provides a simple connection to Schluter®-KERDI-DRAIN



Schluter®-KERDI		
Waterproofing membrane		
Item No.	Dimensions	Thickness
KERDI 200/5M	3' 3" x 16' 5" = 54 ft ² (1 m x 5 m = 5 m ²)	8 mil
KERDI 200/10M	3' 3" x 33' = 108 ft ² (1 m x 10 m = 10 m ²)	8 mil
KERDI 200	3' 3" x 98' 5" = 323 ft ² (1 m x 30 m = 30 m ²)	8 mil

Note: 1 mil = 1 one-thousandth of an inch

Schluter®-KERDI is listed by cUPC® and evaluated by ICC-ES (Report No. ESR-2467).

4 Schluter®-KERDI-BAND and 5 Schluter®-KERDI-KERECK-F

Schluter®-KERDI-BAND is a waterproofing strip used to seal butt joints and floor/wall connections with the KERDI, DITRA, and DITRA-XL mattings.

Schluter®-KERDI-KERECK-F are pre-formed, seamless, inside and outside corners.

Unique Features and Benefits:

- Half the thickness of KERDI (4 mil), to limit buildup at seamed connections



Schluter®-KERDI-BAND			
Waterproofing strip			
Item No.	Width	Length	Thickness
KEBA 100/125/5M	5" - 125 mm	16' 5" - 5 m	4 mil
KEBA 100/185/5M	7-1/4" - 185 mm	16' 5" - 5 m	4 mil
KEBA 100/250/5M	10" - 250 mm	16' 5" - 5 m	4 mil
KEBA 100/125	5" - 125 mm	98' 5" - 30 m	4 mil
KEBA 100/185	7-1/4" - 185 mm	98' 5" - 30 m	4 mil
KEBA 100/250	10" - 250 mm	98' 5" - 30 m	4 mil



Inside Corner



Outside Corner

Schluter®-KERDI-KERECK-F		
Pre-formed waterproofing for inside and outside corners		
Item No.	Thickness	Packaging
KERECK/FI 2	4 mil	2 Inside corners
KERECK/FI 10	4 mil	10 Inside corners
KERECK/FA 2	4 mil	2 Outside corners
KERECK/FA 10	4 mil	10 Outside corners

Note: 1 mil = 1 one-thousandth of an inch

6 Schluter®-KERDI-SEAL-PS/-MV

Schluter®-KERDI-SEAL-PS and -MV prefabricated seals are sections of the Schluter®-KERDI waterproofing membrane with overmolded rubber gaskets that are used to seal pipe protrusions through the KERDI waterproofing membrane and protect moisture-sensitive solid backing panels at the mixing valve.

Unique Features and Benefits:

- Eliminate use of sealant at the specified protrusions
- Half the thickness of KERDI (4 mil), to limit buildup



KERDI-SEAL-PS



KERDI-SEAL-MV

Schluter®-KERDI-SEAL-PS			
Pipe seal with rubber ring			
Item No.	Pipe nipple opening diameter	Thickness	Packaging
KESEAL/PS/125	1/2" - 12.5 mm	4 mil	1 unit
KESEAL/PS/200	3/4" - 20 mm	4 mil	1 unit

Schluter®-KERDI-SEAL-MV			
Mixing valve seal with rubber ring			
Item No.	Mixing valve opening diameter	Thickness	Packaging
KESEAL/MV/114	4-1/2" - 114 mm	4 mil	1 unit

Schluter®-KERDI-SHOWER-KIT

Schluter®-KERDI-SHOWER-KIT is an all-inclusive package containing each of the integrated family of components required to create a watertight shower assembly without a mortar bed. This includes a prefabricated tray, which is available in different sizes, curb, KERDI membrane, KERDI-BAND, KERDI-KERECK-F pre-formed corners, and the KERDI-DRAIN.

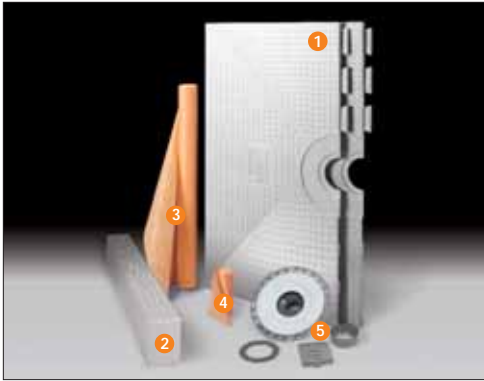

Schluter®-KERDI-SHOWER-KIT		Quantity		
Includes	Description	48" x 48"	72" x 72"	32" x 60"
		1	KERDI-SHOWER-ST Shower Tray	1
2	KERDI-SHOWER-SC Shower Curb 48" x 6" x 4-1/2"	1	2	2
3	KERDI 10 M Waterproofing membrane 3' 3" x 33'	1	2	1
4	KERDI-BAND Waterproofing strip 5" x 33'	1	2	1
5	KERDI-DRAIN Drain, with integrated bonding flange with 2" (50 mm) outlet <small>Includes KERDI-KERECK-F: 4 inside corners, 2 outside corners</small>	1	1	1

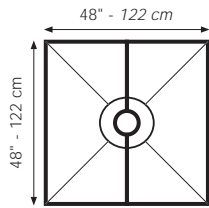

48" x 48" Kit - Select material for drain (ABS or PVC) and grate finish		
Item No.	Drain Material	Grate finish
KK122/ABS/E	ABS	Stainless steel 304 (1.4301 = V2A)
KK122/ABS/ANIGB	ABS	Brushed nickel anodized aluminum
KK122/ABS/AKGB	ABS	Brushed copper/bronze anodized aluminum
KK122/ABS/AMGB	ABS	Brushed brass anodized aluminum
KK122/PVC/E	PVC	Stainless steel 304 (1.4301 = V2A)
KK122/PVC/ANIGB	PVC	Brushed nickel anodized aluminum
KK122/PVC/AKGB	PVC	Brushed copper/bronze anodized aluminum
KK122/PVC/AMGB	PVC	Brushed brass anodized aluminum

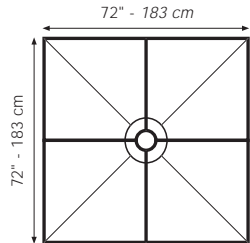

72" x 72" Kit - Select material for drain (ABS or PVC) and grate finish		
Item No.	Drain Material	Grate finish
KK183/ABS/E	ABS	Stainless steel 304 (1.4301 = V2A)
KK183/ABS/ANIGB	ABS	Brushed nickel anodized aluminum
KK183/ABS/AKGB	ABS	Brushed copper/bronze anodized aluminum
KK183/ABS/AMGB	ABS	Brushed brass anodized aluminum
KK183/PVC/E	PVC	Stainless steel 304 (1.4301 = V2A)
KK183/PVC/ANIGB	PVC	Brushed nickel anodized aluminum
KK183/PVC/AKGB	PVC	Brushed copper/bronze anodized aluminum
KK183/PVC/AMGB	PVC	Brushed brass anodized aluminum

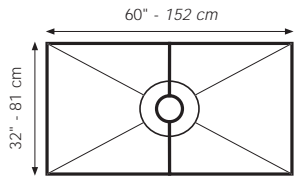

32" x 60" Kit - Select material for drain (ABS or PVC) and grate finish		
Item No.	Drain Material	Grate finish
KK81/152/ABS/E	ABS	Stainless steel 304 (1.4301 = V2A)
KK81/152/ABS/ANIGB	ABS	Brushed nickel anodized aluminum
KK81/152/ABS/AKGB	ABS	Brushed copper/bronze anodized aluminum
KK81/152/ABS/AMGB	ABS	Brushed brass anodized aluminum
KK81/152/PVC/E	PVC	Stainless steel 304 (1.4301 = V2A)
KK81/152/PVC/ANIGB	PVC	Brushed nickel anodized aluminum
KK81/152/PVC/AKGB	PVC	Brushed copper/bronze anodized aluminum
KK81/152/PVC/AMGB	PVC	Brushed brass anodized aluminum

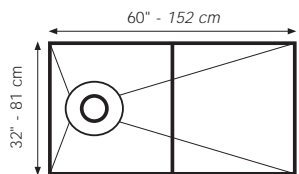

32" x 60" Kit - Select material for drain (ABS or PVC) and grate finish		
Item No.	Drain Material	Grate finish
KKB81/152/ABS/E	ABS	Stainless steel 304 (1.4301 = V2A)
KKB81/152/ABS/ANIGB	ABS	Brushed nickel anodized aluminum
KKB81/152/ABS/AKGB	ABS	Brushed copper/bronze anodized aluminum
KKB81/152/ABS/AMGB	ABS	Brushed brass anodized aluminum
KKB81/152/PVC/E	PVC	Stainless steel 304 (1.4301 = V2A)
KKB81/152/PVC/ANIGB	PVC	Brushed nickel anodized aluminum
KKB81/152/PVC/AKGB	PVC	Brushed copper/bronze anodized aluminum
KKB81/152/PVC/AMGB	PVC	Brushed brass anodized aluminum



Note: Tray features off-center drain placement: 10" (25.4 cm) o.c. from end of tray.

Schluter®-KERDI-FIX

Schluter®-KERDI-FIX is a sealing and bonding compound with a silane-modified polymer base which is used to seal penetrations through the Schluter-KERDI waterproofing membrane. It is also used to bond the KERDI membrane to the stainless steel version of the KERDI-DRAIN. KERDI-FIX is odor-neutral, UV- and weather-resistant, and contains no solvents. It is elastomeric and bonds well to most materials, such as wood, stone, concrete, metal, glass, and many plastics.



Schluter®-KERDI-FIX	
Sealing and bonding compound	
Item No.	Packaging
KERDI-FIX/+ color	Cartridge (290 ml)

*Color Codes	
 BW Bright white	 G Grey

Schluter®-DITRA and DITRA-XL

Schluter®-DITRA and **Schluter®-DITRA-XL** are polyethylene membranes with a grid structure of square cutback cavities and an anchoring fleece laminated to the underside. In conjunction with tiled coverings, DITRA and DITRA-XL form an uncoupling, waterproofing, and vapor management layer, while providing support/load distribution. The combination of these four essential functions allows for the successful installation of tile over a wide range of substrates, including plywood/OSB, concrete, gypsum, heated floors, etc.

Schluter®-DITRA is 1/8" (3 mm) thick, which minimizes tile assembly thickness and reduces transitions to lower surface coverings (e.g., carpet, engineered wood, and vinyl). DITRA allows for ceramic tile application over single layer plywood or OSB subfloors on joists spaced up to 19.2" (488 mm) o.c.



Schluter®-DITRA	
Uncoupling and waterproofing membrane (1/8" - 3 mm thick)	
Item No.	Dimensions
DITRA 5M	3' 3" x 16' 5" = 54 ft ² (1 m x 5 m = 5 m ²)
DITRA 150	3' 3" x 45' 9" = 150 ft ² (1 m x 14 m = 14 m ²)
DITRA 30	3' 3" x 98' 5" = 323 ft ² (1 m x 30 m = 30 m ²)

Schluter®-DITRA-XL is 5/16" (7 mm) thick, which permits even transitions between tile and 3/4"-thick hardwood flooring. DITRA-XL allows for ceramic tile application over single layer plywood/OSB subfloors on joists spaced up to 24" (610 mm) o.c.

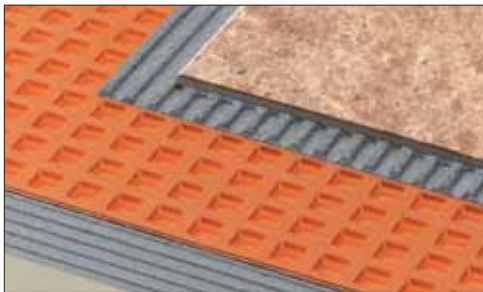

Schluter®-DITRA-XL	
Uncoupling and waterproofing membrane (5/16" - 7 mm thick)	
Item No.	Dimensions
DITRA-XL/175	3' 3" x 53' 3" = 175 ft ² (1 m x 16.4 m = 16.4 m ²)

Schluter®-DITRA/-KERDI Trowels

Used to install Schluter®-DITRA and Schluter®-KERDI membranes. The **DITRA trowel** features an 11/64" x 11/64" (4.5 mm x 4.5 mm) square-notched design while the **KERDI trowel** features a 1/8" x 1/8" (3 mm x 3 mm) square-notched design.



Schluter®-DITRA/-KERDI Trowels		
Trowels used to install Schluter®-DITRA and Schluter®-KERDI membranes		
Item No.	Notch Size	Packaging
TRL-DIT/6	11/64" x 11/64" (4.5 mm x 4.5 mm)	6 units
TRL-KER/6	1/8" x 1/8" (3 mm x 3 mm)	6 units

WARRANTY

Schluter®-Shower System 5-Year Limited Warranty

Subject to the conditions and limitations as stated hereinafter, Schluter Systems* warrants that the **Schluter®-Shower System** (the "Products")** will meet all composition and performance criteria for a period of five (5) years from the date of purchase. This warranty is made upon the express condition and only when the Products are used and installed in accordance with the terms and conditions of the Schluter®-Shower System Installation Handbook and industry standard guidelines that are not in conflict with the Handbook.

If the Products fail to meet this warranty, Schluter Systems, at its election, will a) reinstall or replace the failed portion of the tile assembly or b) pay an amount not to exceed the original square foot cost of the installation of the tile assembly shown to be defective. Tile assembly is defined and limited to include all Schluter®-KERDI Products, non-reusable tile surfaces, and the appropriate setting and grouting materials.

Due to conditions beyond the control of Schluter Systems (e.g., color and shade availability, discontinuation, normal wear and tear), Schluter Systems cannot guarantee or warrant an exact match to the specific tile, stone, or other covering materials used in the installation. In such events, at Schluter Systems' election, substantially similar materials may be substituted.

WARRANTY DISCLAIMER: THERE ARE NO WARRANTIES BEYOND THIS EXPRESSED WARRANTY AS STATED ABOVE. ALL OTHER WARRANTIES, REPRESENTATIONS OR CONDITIONS, EXPRESSED OR IMPLIED, ARE DISCLAIMED AND EXCLUDED, INCLUDING WARRANTIES, REPRESENTATIONS OR CONDITIONS OF **MERCHANTABILITY** OR FITNESS FOR A PARTICULAR PURPOSE ARISING BY STATUTE OR OTHERWISE BY LAW OR FROM A COURSE OF DEALING OR USAGE OF TRADE. SCHLUTER SYSTEMS EXCLUDES AND IN NO EVENT SHALL HAVE ANY LIABILITY FOR LOST PROFITS OR ANY OTHER INDIRECT, SPECIAL, INCIDENTAL, PUNITIVE, EXEMPLARY, OR CONSEQUENTIAL DAMAGES, ARISING OUT OF OR OTHERWISE CONNECTED TO FAILURE OF THE PRODUCTS NOR MISUSE OF THE PRODUCTS OR FAILURE TO PROPERLY MAINTAIN THE SHOWER, STEAM SHOWER, OR BATHTUB SURROUND. REGARDLESS OF ANY STRICT LIABILITY, ACTIVE OR PASSIVE NEGLIGENCE OF SCHLUTER SYSTEMS AND REGARDLESS OF THE LEGAL THEORY (CONTRACT OR TORT OR EXTRA-CONTRACTUAL OR OTHER), NOR FROM ACTS OF WAR, TERRORISM, FAULTY AND NEGLIGENT PENETRATION OF THE SYSTEM, FIRES, EXPLOSIONS, VIBRATION, STRUCTURAL MOVEMENT, EARTHQUAKE, ACTS OF GOD, INTENTIONAL ACTS OF DESTRUCTION OR ANY LOSSES DUE TO STRUCTURAL FAILURE OR OTHER CAUSES UNRELATED TO THE WATERPROOFING SYSTEM OR DELAYS, OR ANY OTHER INCIDENTAL OR CONSEQUENTIAL DAMAGES. THIS WARRANTY IS GIVEN IN LIEU OF ANY OTHER WARRANTY EXPRESSED OR IMPLIED. THE REMEDIES CONTAINED HEREIN ARE THE ONLY REMEDIES AVAILABLE FOR BREACH OF THIS WARRANTY.

NO ASSIGNMENT-TERRITORY: This Limited Warranty extends ONLY to the original end-user (defined as homeowner – owner of the premises/unit owner) for sales made ONLY in the United States and Canada and is not transferable or assignable, unless otherwise prohibited by specific state or provincial law.

SUITABILITY OF PRODUCTS: IT IS THE RESPONSIBILITY OF THE OWNER/BUILDER/INSTALLER TO ENSURE THE SUITABILITY OF ALL BUILDING MATERIALS AND ALL ASSOCIATED BUILDING MATERIALS FOR THE OWNER'S INTENDED USE. IT IS RECOMMENDED THAT THE OWNER CONSULT WITH AN EXPERIENCED AND PROFESSIONAL INSTALLER.

CLAIMS ON THIS LIMITED WARRANTY: To make a claim under this Limited Warranty, the owner must provide Schluter Systems with written notice within 30 days of any alleged defect in the Products covered by this Limited Warranty, together with date and proof of purchase of the Products, proof of the costs of the original installation and name and address of all installers, failing which this Limited Warranty shall be of no legal effect. Schluter Systems reserves the right at its election and as a condition of this Limited Warranty to inspect the alleged failure and defect prior to any repair.

This warranty shall supersede and replace any and all prior oral or written warranties, agreements, or other such representations made by or on behalf of Schluter Systems relative to the Products or the application of the Products and shall apply to any installation occurring on or after June 16, 2008. **No changes or modification of any terms or conditions of this warranty are allowed unless authorized by written agreement and signed by the General Manager or an Officer of Schluter Systems L.P.**

*For the purpose of this warranty **Schluter Systems L.P.** shall provide the warranty for all products for end users located in the United States and **Schluter Systems (Canada) Inc.** shall provide the warranty for all products for end users located in Canada. **Schluter Systems L.P.** and **Schluter Systems (Canada) Inc.** are affiliated companies.

All U.S. Claims shall be sent to:

Schluter Systems L.P.
Attn: Warranty Claims Dept.
194 Pleasant Ridge Road
Plattsburgh, New York 12901

All Canadian Claims shall be sent to:

Schluter Systems (Canada) Inc.
Attn: Warranty Claims Dept.
5626 Thimens Blvd.
St-Laurent, Quebec
H4R 2K9



****Schluter®-Shower System (the "Products"):** The Products are defined to include all Schluter®-KERDI Products referred to in the Handbook and used in the integrated Schluter®-Shower System.



PROFILE OF INNOVATION



Schluter Systems L.P. • 194 Pleasant Ridge Road, Plattsburgh, NY 12901-5841 • Tel.: 1-800-472-4588 • Fax: 1-800-477-9783
Schluter Systems (Canada) Inc. • 5626 Thimens Blvd., St. Laurent, QC H4R 2K9 • Tel.: 1-800-667-8746 • Fax: 1-514-336-2410
Internet: <http://www.schluter.com> • E-mail: info@schluter.com